

PLX Panel Convactor Heaters

INDPUKP5RG Issue 6

Dimensions

(millimetres)

Model(s)	Watt	A	B	X
PLX 500/NC/TI	500	450	108	116
PLX 750/NC/TI	750	620	108	286
PLX 1000/NC/TI	1000	620	108	286
PLX 1250/NC/TI	1250	688	108	354
PLX 1500/NC/TI	1500	688	108	354
PLX 2000/NC/TI/TX	2000	860	108	526
PLX 3000/TI/TX	3000	860	143	526

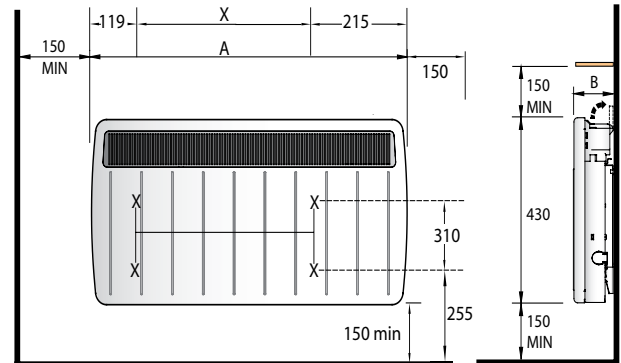

Fig. 1

IMPORTANT: THESE INSTRUCTIONS SHOULD BE READ CAREFULLY AND RETAINED FOR FUTURE REFERENCE

Important Safety Advice

When using electrical appliances, basic precautions should always be followed to reduce the risk of fire, electrical shock, and injury to persons, including the following:

IMPORTANT – The wall bracket supplied with the appliance must be used.

WARNING – Do not use this heater in the immediate surroundings of a bath, a shower or a swimming pool.

IMPORTANT – If the heater is installed in a room containing a bath or shower, it must be so installed that switches and other controls cannot be touched by a person using a bath or shower.

Do not use outdoors.

Do not locate the heater immediately below a fixed socket outlet or connection box.

WARNING: In order to avoid overheating, do not cover the heater. Do not place material or garments on the heater, or obstruct the air circulation around the heater, for instance by curtains or furniture, as this could cause overheating and a fire risk.

NEVER cover or obstruct in any way the heat outlet slots at the top of the heater or the air inlet slots in the base of the heater.

 The heater carries the Warning symbol indicating that it must not be covered.

CAUTION - Some parts of this product can become very hot and cause burns. Particular attention has to be given where children and vulnerable people are present.

This appliance can be used by children aged from 8 years and above and by persons with reduced physical, sensory or mental capabilities or lack of experience and knowledge if they have been given supervision or instruction concerning use of the appliance in a safe way and understand the hazards involved.

Children shall not play with the appliance. Cleaning and user maintenance shall not be made by children without supervision.

Children of less than 3 years should be kept away unless continuously supervised.

Children aged from 3 years and less than 8 years shall only switch on/off the appliance provided that it has been placed or installed in its intended normal operating position and they have been given supervision or instruction concerning use of the appliance in a safe way and understand the hazards involved. Children aged from 3 years and less than 8 years shall not plug in, regulate and clean the appliance or perform user maintenance.

Note that due care and consideration must be taken when using this heater in series with a thermal control, a program controller, a timer or any other device that switches on the heat automatically, since a fire risk exists when the heater is accidentally covered or displaced.

If the supply cord is damaged it must be replaced by the manufacturer or service agent or a similarly qualified person in order to avoid a hazard.

WARNING: Servicing and product repairs should only be undertaken by the manufacturers approved service agent or a similarly qualified person, using only exact manufacturer approved spare parts.

IMPORTANT – The supply circuit to the heater must incorporate a double pole isolating switch having a contact separation of at least 3mm.

WARNING: PLX****NC heaters are not equipped with a device to control the room temperature. Do not use these heater in small rooms when they are occupied by persons not capable of leaving the room on their own, unless constant supervision is provided.

Electrical

WARNING – THIS APPLIANCE MUST BE EARTHED

The electrical installation must be carried out by a competent electrician, and be in strict accordance with the current I.E.E. regulations for Electrical Equipment in Buildings.

The heater is fitted with a length of flexible cable type H05VV-F size 3 x 1.0mm² on models PLX 500 - 2000 and size 3 x 1.5mm² on PLX 3000 models, for connection to the fixed wiring of the premises through a suitable connection box positioned adjacent to the heater.

The supply circuit to the heater must incorporate a double pole isolating switch having a contact separation of at least 3mm.

Supplementary Earth Bonding

Should Equipotential Earth Bonding be required the earthing conductor in the supply cord is deemed to provide the supplementary bonding connection (see Regulation 544.2.5, 17th Edition I.E.E. Wiring Regulations).

General

NOTE: The PLX Convector is designed for wall mounting on the wall brackets supplied. The wall brackets supplied with the appliance must be used. It should only be operated when in the upright position as shown.

All models are splashproof to IP24 standard.

Models PLX...TI are fitted with a 24 hour programmable timer.

Models PLX...TX are fitted with a 7 day programmable timer.

Models PLX...NC are fitted with no controls, for use with external thermostatic or programming controllers.

Before connecting the heater check that the supply voltage is the same as that stated on the heater.

Please note that lit cigarettes, candles and oil burners, combined with the convection effect of electric heaters can cause soot deposits to build up on the surface directly above and to the sides of the heater. This is not the fault of the heater. Extensive burning of candles or smoking in the operating environment of this product can produce heavy discoloration within a few months of use.

Wall Mounting

IMPORTANT – The wall brackets supplied with the appliance must be used. The heater should be positioned observing the minimum clearances stated around the heater - see Fig. 1.

DO NOT locate the heater immediately below a fixed socket outlet or connection box.

1. Remove wall mounting bracket from the back of the heater by depressing the spring latch at the top of each bracket - see Fig. 2.
2. Fix the wall bracket securely to the wall through the four screw holes provided.
3. Present the heater to the wall bracket, and engage lower slots in the back with bracket.
4. Raise the heater to upright position and push the heater onto brackets to engage top latch.

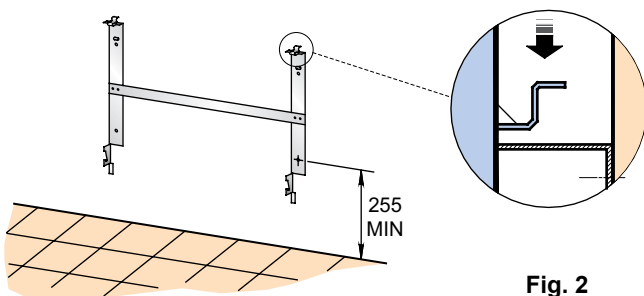

Fig. 2

Access to the controls

The controls cover (see 'x' in Fig. 1) on your heater has a latch which may be locked shut if desired using a small bladed screwdriver - see Fig. 3.

To open the cover insert the blade of the screwdriver in the small slot and rotate a quarter of a turn clockwise to disengage the latch. The cover may then be hinged back towards the wall for access to the controls.

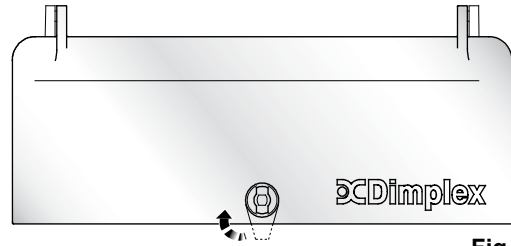

Fig. 3

Operation - Thermostat only models

Control of Output and Temperature (see Fig. 4)

The switch marked O and I controls the electricity supply to the heating elements. The OFF position is marked O.

The switch marked I - II (half heat – full heat) provides a choice of output as desired.

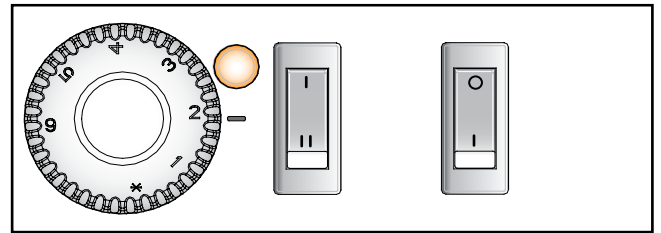

Fig. 4

Thermostat Operation

The heater is fitted with an adjustable thermostat enabling the room temperature to be controlled by adjusting the setting accordingly. The * setting represents a room temperature of approximately 5°C and may be used for protection against frost. Higher temperature settings range from 1-6 (max.) creating a room temperature of approximately 30°C.

A neon indicator light glows when the appliance is actually heating.

Switch on the heater and turn the thermostat knob to mark 6 opposite the indicator mark (located on centre right of the knob - see Fig. 4 & 5), and set selector switch to full heat output to warm the room rapidly. When the room temperature has reached the desired level, turn the thermostat knob back slowly until the thermostat just clicks off. The heater will then maintain the room temperature at the chosen level, provided that the correct size of heater has been selected for the room to be heated.

NOTE – Should your heater fail to come on when the thermostat knob is at a low setting, this may be due to the room temperature being higher than the thermostat setting.

Operation - TI and TX Timer Models

Control of Output and Temperature (see Fig. 5)

The slide switch on the timer unit controls the electricity supply to the heating elements on TI and TX models.

The switch marked I - II (half heat – full heat) provides a choice of output as desired.

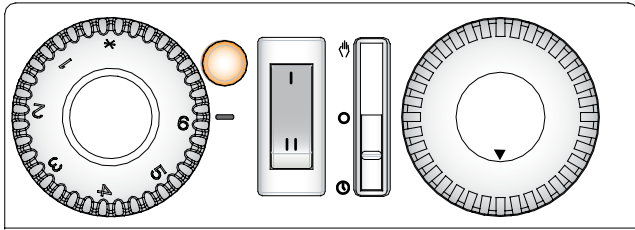

Fig. 5

Thermostat Operation

- see above.

Using the Timer

The heater must be connected to the electricity supply for the timer to operate. Set the timer by rotating the dial clockwise until the correct time of day is indicated opposite the datum mark (located at centre front of the timer - see Fig. 5).

'OFF' Position

Set the timer switch to  position. The timer operates but the heater will not output any heat, as the electricity supply to the heating elements has been disconnected.

Manual Operation

Set the timer switch to  position. The heater will now operate continuously under the control of the thermostat - see 'Thermostat Operation' above.

Automatic Operation

Set the timer switch to  position. The panel will now operate during set 'ON' periods under the control of the thermostat.

To set the timer's 'ON' and 'OFF' periods:

1. Using your finger tip or the tip of a pencil, push in as many segments as necessary around the dial, according to the times you don't require heat – see Fig. 6. Each segment pushed in switches the heater OFF for that part of the hour. All other segments will be 'ON'.

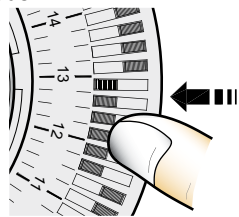

Fig. 6

2. You can select as many 'ON' periods as you like, within the 24-hour day. The settings will repeat every day until changed.

3. To change 'ON' and 'OFF' times, simply push in any 'ON' segments you wish to cancel and pull out new 'ON' segments as required.

Note: On TI models each segment on the timer represents 20 mins.

TX Models

TX Models are fitted with 7 day programmable timers. In all other respects they are identical in installation and operation to 24 hour timer operation on TI models.



1. Setting the Time

The current day and time is set by rotating the timer dial clockwise until the correct day and time is indicated opposite the datum mark.

2. Automatic Operation

Set the time switch to the  symbol. Select the days and

times you require the heater to come on by pulling out the appropriate segments. Each segment represents a 2 hour 20 minute period for the day indicated. The timer may be set to give as many 'ON' periods of any length required in multiples of 2 hours and 20 minutes. The programme will repeat itself every 7 days until changed.

The programme may be over-ridden at any time by switching to  or  and can be reinstated by switching back to  setting.

Safety - Overheat protection

For your safety this appliance is fitted with a thermal cut-out. In the event that the product overheats for some reason, the cut-out prevents excessive temperatures on the product by cutting the power to the heater. Once the heater has cooled down, it will reset automatically, it will continue to cycle on and off automatically until the reason for overheating is removed.

Cleaning

Before commencing cleaning, unplug the heater and allow it to cool. Disconnect the electricity supply to the appliance.

The outside can be cleaned by wiping it over with a soft damp cloth and then dried. Do not use abrasive cleaning powders or furniture polish, as this can damage the surface finish.

To release heater from the wall bracket for cleaning or redecoration, depress latch on both brackets (see Fig. 2) and hinge forward.

Recycling

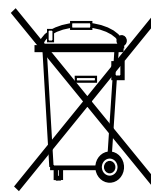

For electrical products sold within the European Community.

At the end of the electrical products useful life it should not be disposed of with household waste. Please recycle where facilities exist. Check with your Local Authority or retailer for recycling advice in your country.

After Sales Service

If this product appears damaged when first received or does not function correctly contact us by email aftersales@dimplex.co.uk or call 0844 879 3588 and we will be able to help. For ROI please call 01 842 8222.

Do Not Return the product in the first instance as this may delay us providing you with a satisfactory service.

ACCIDENTAL DAMAGE IS NOT COVERED UNDER THE WARRANTY.

Your product is guaranteed for two years from date of purchase. Within this period we undertake to repair this product free of charge provided it has been installed and operated in accordance with these instructions. Should you require assistance with this product please go to www.dimplex.co.uk and click on "Customer Support" or email us at aftersales@dimplex.co.uk

Alternatively call our contact centre on 0844 879 3588 (UK only). This is a Lo-call no. from a BT landline - other providers including mobile phones may charge you more. For ROI please call 01 842 8222.

To assist you, we will need the following information: model no and serial no (these can be found on the product), nature of the fault and date of purchase. **Please retain your receipt as proof of purchase.** Your rights under this guarantee are additional to your statutory rights, which in turn are not affected by this guarantee.

Spares can be purchased online, go to www.dimplex.co.uk/outlet_store

Energy Saving Tips

The energy we use to heat, light and power our homes contributes over a quarter of the UK's carbon emissions, the principle contributor to climate change.

Around half the energy used in the home is for heating and hot water, so using your heating system efficiently will not only help the environment, but also save you money !

Energy efficiency tips for heating and hot water

1. Don't set the temperature too high...

By reducing the thermostat setting by just 1°C can reduce your energy use by as much as 10%. And if you're going away for the winter, leave the thermostat on the frost protection setting to provide protection from freezing at a minimum cost.

2. Use it where you need it...

Set the appropriate temperature on your heaters for the room they are in; for example, leave the thermostat on a heater in a spare bedroom on a lower setting.

3. Use it when you need it...

Use heaters fitted with timers or linked to central controllers to turn the heating on only when you need it and automatically switch it off when you don't.

4. Curtains...

Close your curtains at dusk to stop heat escaping through the windows.

5. Windows...

Nearly 25% of heat loss can occur through poorly insulated frames and single glazing. If you can't afford to double glaze all your windows, go for the rooms you heat most.

6. Treat your hot water tank... give it a jacket

An insulating jacket for hot water tanks only costs a few pounds and pays for itself within months. Fit one that's at least 75mm (3") thick and you could save £10-£15 a year.

7. Water...

Use a shower if you have one to save time, money and water.

Don't set the thermostat too high on your water heater - 60°C/140°F is usually adequate for bathing and washing.

Put the plug in when running hot water in your sink - leaving hot taps running is both wasteful and expensive.

Ensure dripping taps are repaired quickly. In just one day, you could waste enough water to fill a bath.

Other Energy Saving Tips for Around the Home

1. Lights

Turn off lights whenever you leave a room for more than ten minutes.

Use low-energy bulbs wherever you can as they use less than a quarter of the electricity used by ordinary light bulbs and last ten times longer!

2. Cooking

Use the right size pan for the food and cooker hob.

Keep saucepan lids on - this enables you to turn down the heat.

Boil water for cooking in a kettle.

 The product complies with the European Safety Standards EN60335-2-30 and the European Standard Electromagnetic Compatibility (EMC) EN55014, EN60555-2 and EN60555-3. These cover the essential requirements of EEC Directives 2006/95/EC and 2004/108/EC

DIMPLEX
MILLBROOK HOUSE
GRANGE DRIVE
HEDGE END
SOUTHAMPTON
SO30 2DF

TEL: 0844 879 3588

WEBSITE: www.dimplex.co.uk

Republic of Ireland Tel. 01 842 8222

[c] GDC Group Ltd,

All rights reserved. Material contained in this publication may not be reproduced in whole or in part, without prior permission in writing of Dimplex.
A division of GDC Group Ltd.